

tagra[®]

Pro Architectural Specification

For LED Neon Flex Ribbon

Single Colour



Table of Contents

Introduction	03
1. Specifications & Parameters	04
1.1 Dimensions of Light	
1.2 Technical Parameters	
1.3 Optical Parameters	
2. Functions & Features	05
2.1 Product Features	
2.2 Minimum Bend Diameter	
3. Types of Connector	05
3.1 Injection-moulded Connector	
3.2 Swivel Connector	
3.3 Male & Female Connector	
4. Mounting Profile	08
4.1 Hybrid Profile	
4.2 Trimless Profile	
5. Appendix	10
6.2 Certificate	
6.3 Third-Party Test Report	
6.4 Reliability Test of Light	
6.5 Figures of Typical Characteristics	
6.6 (X,Y) Chromaticity Diagram	
6.7 Correlated Color Temperature	
6.8 Wavelength of Color Light	
6.9 Loading Chart	

Introduction

Pro Architectural is made of silicone, it has a micro square profile and superior even illumination, both horizontal bending and vertical bending options are available.

Pro Architectural is UL/cUL, CE and RoHS compliant. Moreover, it has been passed environmental resistance, optical, mechanical and electrical tests in our lab under the support of advanced experimental equipment and technology to ensure it meets the requirements of harsh environments. Also, it has been passed relevant tests of third party inspection authority.

Fully encapsulated in the silicone chamber by utilizing consummate extrusion technology, assembled with injection-moulded connectors to achieve IP67 protection, easy for installation and applicable for various circumstances.

Available in wide range of white color temperatures with only one bin and high CRI LEDs, Red, Blue, Green and Amber colors are also optional, which enables endless possibilities of application.

Applications:

1. Contour/Border Lighting
2. Architectural Decorative Lighting
3. Cove/Accent Lighting
4. Floor/Stair Lighting
5. Signage/Guide Lighting
6. Furniture/Cabinet Lighting

1. Specifications & Parameters



1.1 Dimensions of Light

Pro Architectural

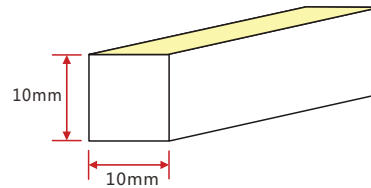
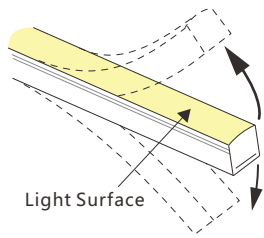

Note: Unless otherwise stated, the tolerance of the light is $\pm 0.3\text{mm}$.

1.2 Technical Parameters

Technical Parameters

Article No.	Pro Architectural Single
Color	Red/Green/Blue/Amber/White
Working Voltage	DC24V
Rated Power/m	4.5W
LED Qty/m	144LEDs
LED Distance	6.9mm
Min. Cutting Unit	12LEDs (1unit)
Min. Cutting Length	83.3mm(1unit)
Continuous Length	15m
Package Length	$\leq 20\text{m}$
Weight/m	130g
Storing Temp.	-40~60°C
Ambient Working Temperature	-40~55°C
Ambient Installation Temperature	-40~50°C
IP Rating	IP67

1.3 Optical Parameters

Photometric Data

Article No.	Pro Architectural Single				
LED Type	SMD				
Beam Angle 50%	120°				
Color	Wavelength	Lumen/m	Color	CCT	Lumen/m
Red	618-624nm	>80lm	2200K	2238 \pm 102K	>220lm
Green	522-528nm	>220lm	2700K	2725 \pm 145K	>220lm
Blue	468-474nm	>50lm	3000K	3045 \pm 175K	>220lm
Amber	588-594nm	>80lm	4000K	3985 \pm 275K	>220lm
			5700K	5669 \pm 355K	>220lm

Candle power distribution

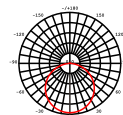

Illuminance Characteristics

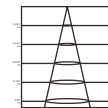

2. Functions & Features

2.1 Product Features

1. High quality and high brightness SMD LED chip, each two LEDs circuit protected.
2. Smallest square physical size 10*10mm to enable new applications.
3. Wide range of solid white color options.
4. Horizontal and vertical bending optional for easily custom design.
5. UV & flame resistant construction(silicone).
6. High color consistency & smooth illumination with non visible light dots.
7. Super flexible with 100mm minimum bending diameter.
8. Innovative mounting profiles and mini connectors for easy installation.
9. Continuous length up to 15m by powering one end.
10. Low power consumption, low heat, energy efficient & environmentally friendly.
11. Automated production, high reliability & long warranty.
12. 5 years life span.

2.2 Minimum Bend Diameter

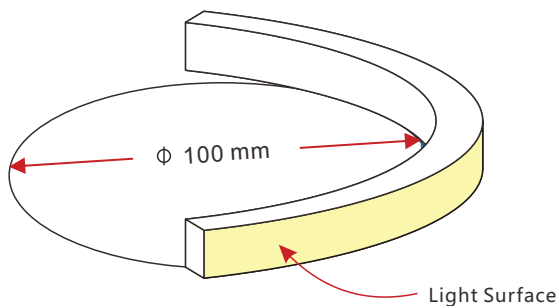

The light can only be bent along the light surface. Do not bend smaller than allowed minimum bend diameter.

3. Types of Connector

3.1 Injection-moulded Connector

Note:

1. Unless otherwise stated, the tolerance of the connector is $\pm 0.5 \text{ mm}$;
2. Continuous length up to 15m by powering one end.



Injection-moulded Front Connector (bottom)

Connects light to power supply with pre-installed bottom feed cable IP67. Cable length available in 0.3m, 1m, 3m, 5m, 10m lengths.

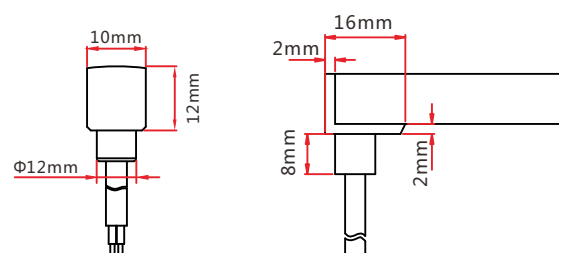

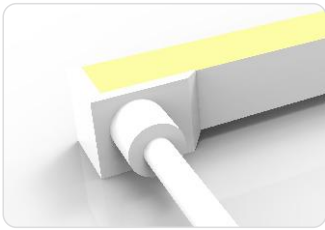

Injection-moulded Front Connector (side)

Connects light to power supply with pre-installed side feed cable, IP67. Cable length available in 0.3m, 1m, 3m, 5m, 10m lengths.

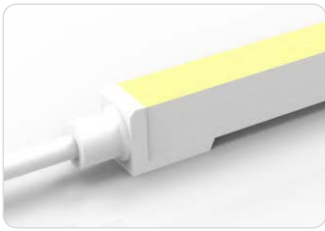
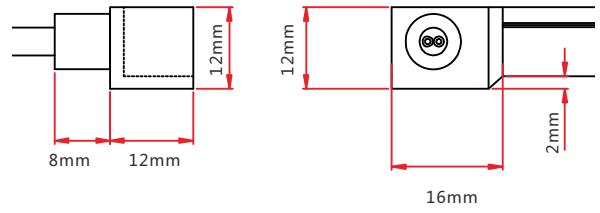

Injection-moulded Front Connector (end)

Connects light to power supply with pre-installed end feed cable, IP67. Cable length available in 0.3m, 1m, 3m, 5m, 10m lengths.

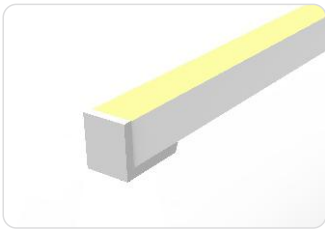
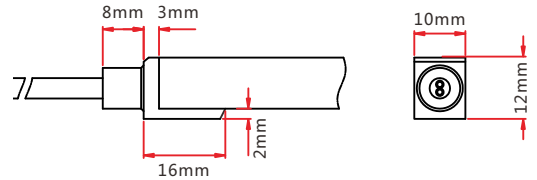

Injection-moulded End Cap

Pre-installed termination protection of the light, IP67.

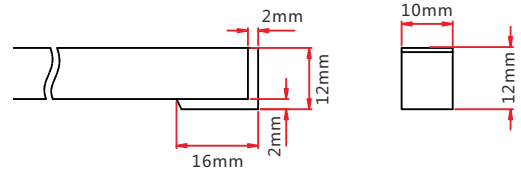

3.2 Swivel Connector

Note:

1. Unless otherwise stated, the tolerance of the connector is $\pm 0.5\text{mm}$;
2. Continuous length up to 15m by powering one end.

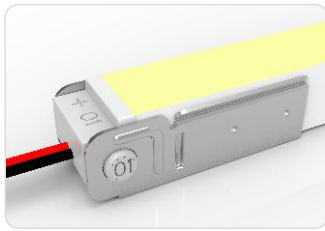

Swivel Front Connector (top end)

Connects light to power supply, IP20. DIY connector. Cable available in 0.3m, 1m lengths.

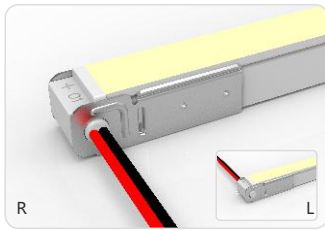
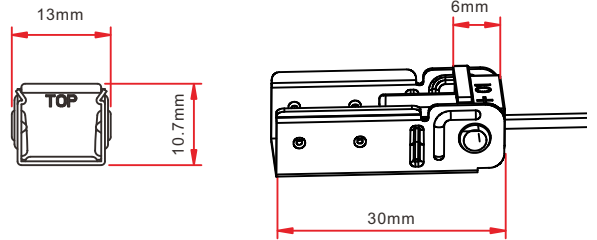

Swivel Front Connector (side right/left)

Connects light to power supply, IP20. DIY connector. Cable available in 0.3m, 1m lengths.

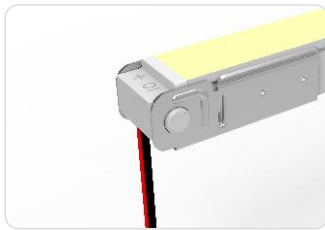
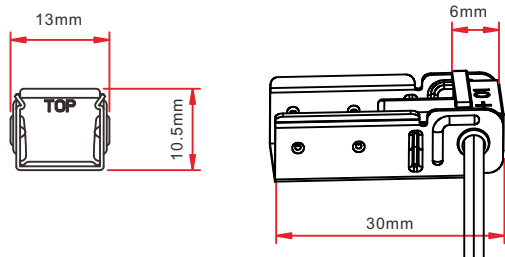

Swivel Front Connector (bottom)

Connects light to power supply, IP20. DIY connector. Cable available in 0.3m, 1m lengths.

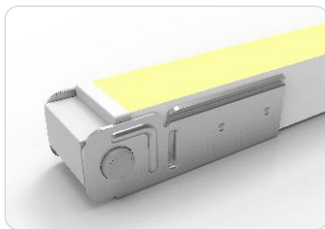
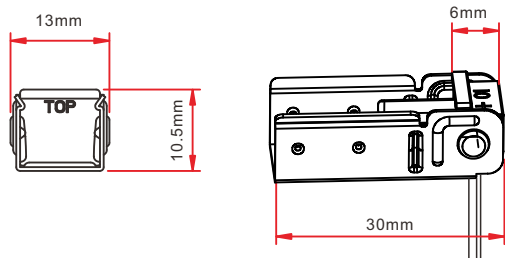

Swivel End Cap

Termination protection of the light, IP20 DIY connector.

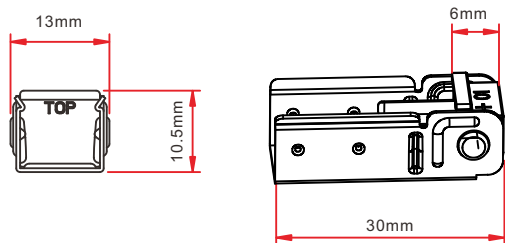

3.3 Male & Female Connector

Note: Unless otherwise stated, the tolerance is $\pm 2\text{mm}$.



Male & female Connector

For plug and play cable junction, DIY or Pre-installed connector, IP68

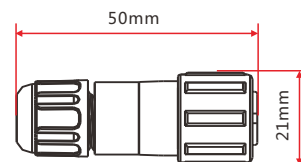

4. Mounting Profile

4.1 Hybrid Profile

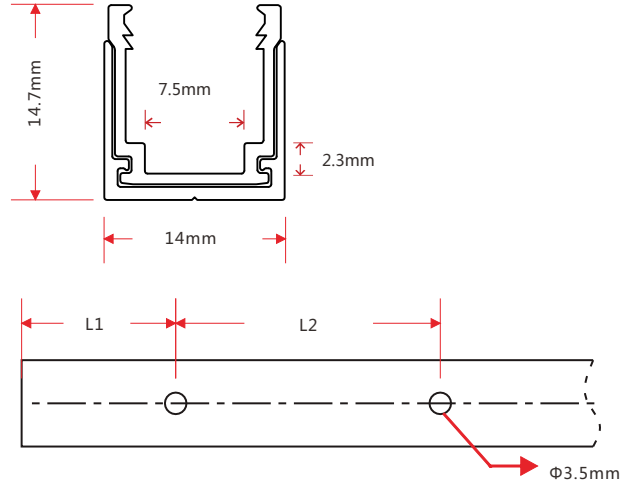
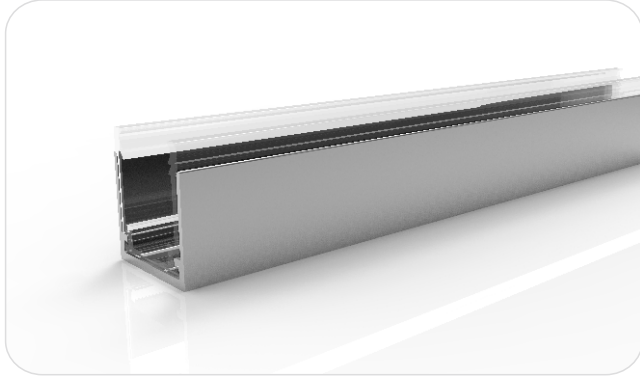

Note: Unless otherwise stated, the tolerance of the profile is ±0.5mm.

Installation Way



Model	W*H(mm)	Standard Length (mm)	L1 (mm)	L2 (mm)	Screw Hole (mm)	Hole Number	For Product
F23-PA/PL	14*14.7	35	17.5	/	Φ3.5	1	F23
		500	50	200	Φ3.5	3	F23
		1000	100	200	Φ3.5	5	F23
		2000	100	200	Φ3.5	10	F23

4.1 Recessed Mounting Profile

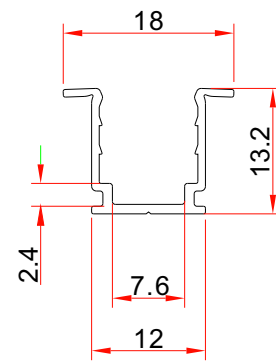

Note: Unless otherwise stated, the tolerance of the profile is ±0.5mm.

Installation Way



Model	W*H(mm)	Standard Length (mm)	L1 (mm)	L2 (mm)	Screw Hole (mm)	Hole Number	For Product
F23-RMA/PL	18*13.2	35	5	25	Φ3.5	2	F23
		500	50	200	Φ3.5	3	F23
		1000	100	200	Φ3.5	5	F23
		2000	100	200	Φ3.5	10	F23

6. Appendix

6.3 Third-Party Test Report

Testing Item RoHS	Testing Organization	Report Number
	SGS	CANEC1202163502 A01

>>Note: The testing reports and certificates are available from the related official website.

6.4 Reliability Test of Light

TESTING ITEM	PERFORMANCE	STANDARD/REFERENCE VALUE/DESCRIPTION
PHOTOMETRIC TESTING	Spectrum Analysis	IES LM 79 (lumen, CCT, CRI, XY, SDCM, wave length)
	Photometric Distribution	IES LM 79(lumen intensity distribution & Lux diagram)
	Lumen maintenance & Life time	IES LM84 & IES TM28
MECHANICS & PHYSICS TESTING	Bending Test	Manufacturer-defined, 500 cycles
	Tensile Test	Manufacturer-defined, > the weight of light in maximum connection length with both ends feed
	Twist Test	Manufacturer-defined, >200 cycles

6.2 Certificate

Certificating Type	Testing Organization	Certificate Serial Number	Report Reference
CE-EMC	SGS	SZEM1712012372LMV	SZEM171201237201

6.5 Figures of Typical Characteristics

- Vertical Bend
- Horizontal Bend

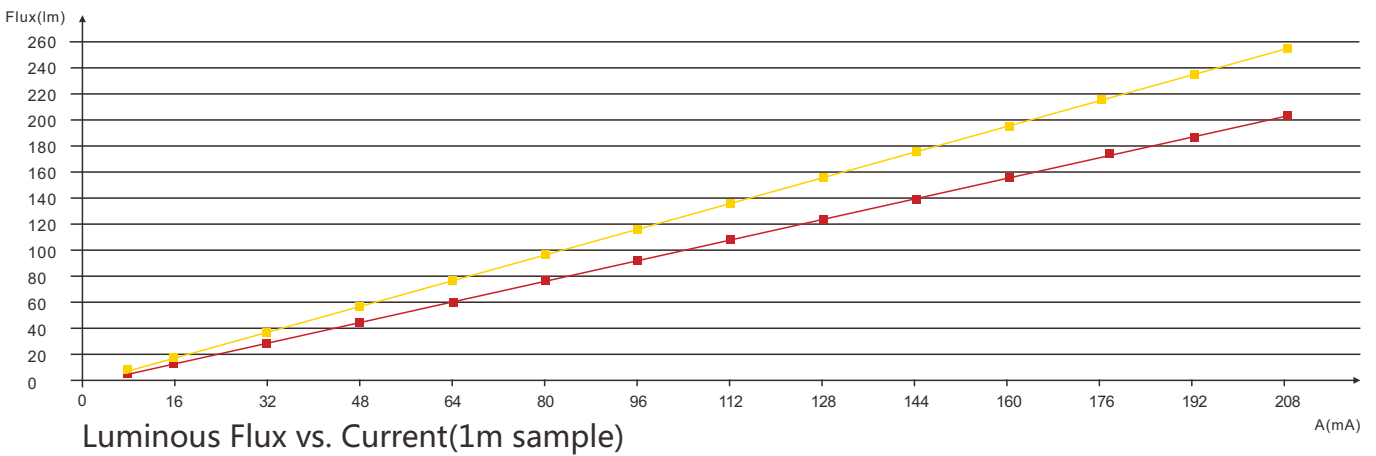
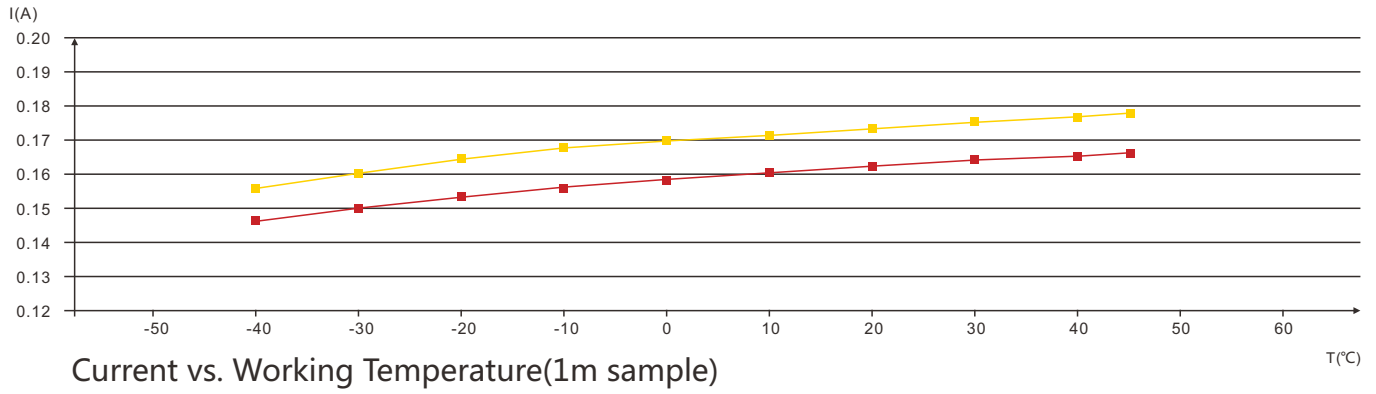

55

6.6 (X,Y) Chromaticity Diagram

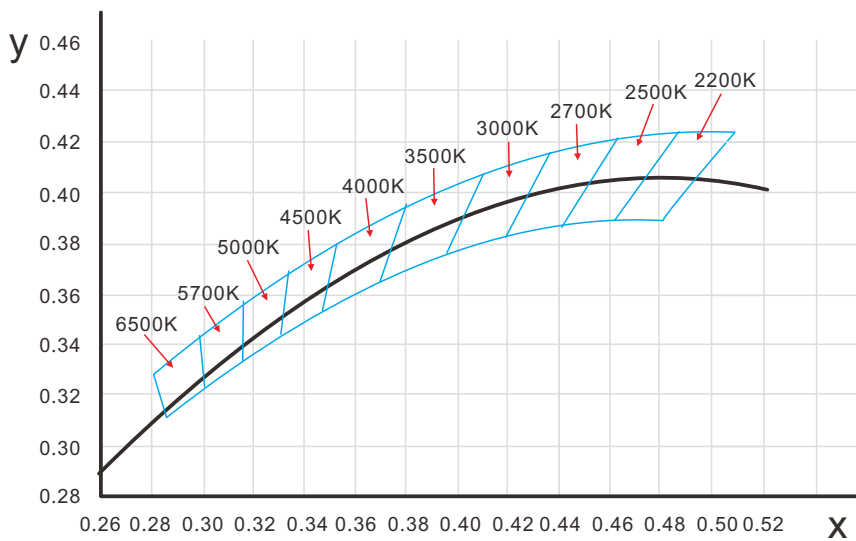

6.7 Correlated Color Temperature

ANSI STANDARD



Nominal CCT Categories

Nominal CCT	Target CCT and tolerance(K)	Target D_{uv}	D_{uv} Tolerance Range
2200K	2238 ±102	0.0000	T_x :CCT of the source
2500K	2460±120	0.0000	For $T_x < 2870K$
2700K	2725 ±145	0.0000	0.000±0.0060
3000K	3045±175	0.0001	For $T_x \geq 2870K$
3500K	3465±245	0.0005	$D_{uv}(T_x) \pm 0.0060$
4000K	3985±275	0.0010	where
4500K	4503±243	0.0015	$D_{uv}(T_x) = 57700 \times (1/T_x)^2$
5000K	5029±283	0.0020	-44.6 x (1/ T_x)
5700K	5667±355	0.0025	+0.00854
6500K	6532±510	0.0031	
Flexible CCT (2200-6500K)	$T_F^{1)} \pm \Delta T^{2)}$	$D_{uv} T_F^{3)}$	

Remark:

- 1) T_F is chosen to be at 100K steps (2300,2400,.....,6400K),excluding the ten nominal CCTs listed in Table 1.
- 2) $\Delta T = 1.1900 \times 10^8 \times T^3 - 1.5434 \times 10^4 \times T^2 + 0.7168 \times T - 902.55$
- 3) Same as in the D_{uv} Tolerance Range.

6.8 Loading Chart

Type.	Rated Power /mtr	Power Supply						
		35w	60w	60w	75w	80w	100w	120w
F23	4.5w	6m	10m	11m	13m	14m	15m	20m
Energizing way		DC input 			DC input  DC input			

- Note : 1. These are the light maximum recommended running length subject to selected power supply.
 2. For example: It is recommended to use one 80W power supply loading maximum 13m light by energizing the light one end or use one 150W power supply loading maximum 24m by energizing the light both ends.