



Pro Plus Architectural Specification

For LED Neon Flex Ribbon

RGB

Table of Contents

Introduction	03
1. Specifications & Parameters	04
1.1 Dimensions of Light	
1.2 Technical Parameters	
1.3 Optical Parameters	
2. Functions & Features	05
2.1 Product Features	
2.2 Minimum Bend Diameter	
3. Types of Connector	05
3.1 Injection-moulded Connector	
3.2 Anti-wicking Ferrule	
3.3 Male & Female Connector	
4. Mounting Profile	07
4.1 Plastic Profile	
4.2 Spring Clip Aluminium Profile	
4.3 Hybrid Profile	
4.4 Cable Exit Oriented Aluminium Profile	
(Applicable to Injection-moulded Connector Only)	
4.5 Corner Aluminium Profile	
(Applicable to Injection-moulded Connector Only)	
4.6 Bendable Stainless Steel Profile	
4.7 Recessed Mounting Profile	
5. Packaging	12
6. Appendix	13
6.2 Certificate	
6.3 Third Party Test Report	
6.4 Reliability Test of Light	
6.5 Figures of Typical Characteristics	
6.6 Wavelength of Color Light	
6.7 Loading Chart	

Introduction

Pro Plus Architectural is UL/cUL, CE, TUV and RoHS compliant. Moreover, it has passed environmental resistance, optical, mechanical and electrical tests in our lab under the support of advanced experimental equipments and technology to ensure it meets the requirements of harsh environments. Also it has passed relevant tests for third party inspection authority.

Fully encapsulated in the flexible silicone chamber by utilizing consummate extrusion technology, assembled with injection-moulded connectors to achieve IP67 protection, easy for installation and applicable for various circumstances.

Pro Plus Architectural features dynamic color effects with smooth color-mixing illumination and small bend diameter in wave bending shape.

Applications:

1. Outdoor or Indoor Contour/Border Lighting
2. Architectural Outline/Decorative Lighting
3. Cove/Accent Lighting
4. Signage/Statue
5. Display Lighting

1. Specifications & Parameters

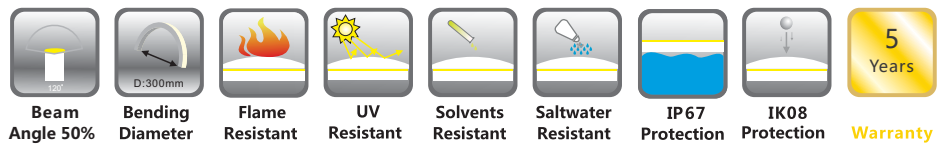

1.1 Dimensions of Light

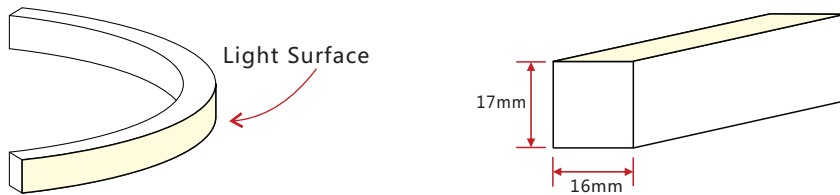

Note: Unless otherwise stated, the tolerance of the light is $\pm 0.3\text{mm}$.

1.2 Technical Parameters

Technical Parameters

Article No.	Pro Plus Architectural RGB
Color	RGB
Working Voltage	DC24V
Rated Power/m	12W
LED Qty/m	84LEDs
LED Distance	11.9mm
Min. Cutting Unit	7LEDs (1unit)
Min. Cutting Length	83.3mm(1unit)
Continuous Length	10m
Package Length	$\leq 36\text{m}$
Weight/m	365g
Storage Temperature	-40~60°C
Ambient Working Temperature	-40~55°C
Ambient Installation Temperature IP	-40~50°C
Rating	IP67

1.3 Optical Parameters

Photometric Data

Article No.	Pro Plus Architectural RGB		
LED Type	SMD		
Beam Angle 50%	120°		
Color	CCT/Wavelength	Lumen/m	Power/m
Red	618-624nm	> 90lm	
Green	522-528nm	> 200lm	
Blue	468-474nm	> 40lm	
White(R+G+B)	/	> 330lm	12w

Candle power distribution

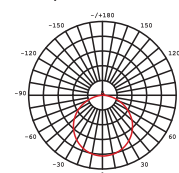

Illuminance Characteristics

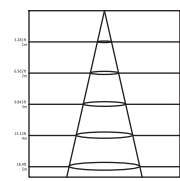

2. Functions & Features

2.1 Product Features

1. High quality SMD LED chip.
2. UV & flame resistant construction(silicone).
3. Extremely flat profile for slimline projects.
4. Perfect uniform & even light source with invisible light dots.
5. High illumination.
6. Easily to be installed.
7. High IP rating (IP67).
8. The product IP rate is ultimately in line with properly applied IP rated connectors.
9. Continuous length up to 10m(Injection-moulded) by powering one end.
10. Environmentally friendly & energy efficient.
11. Automated production, high reliability & long warranty.
12. 5 year life span.

2.2 Minimum Bend Diameter

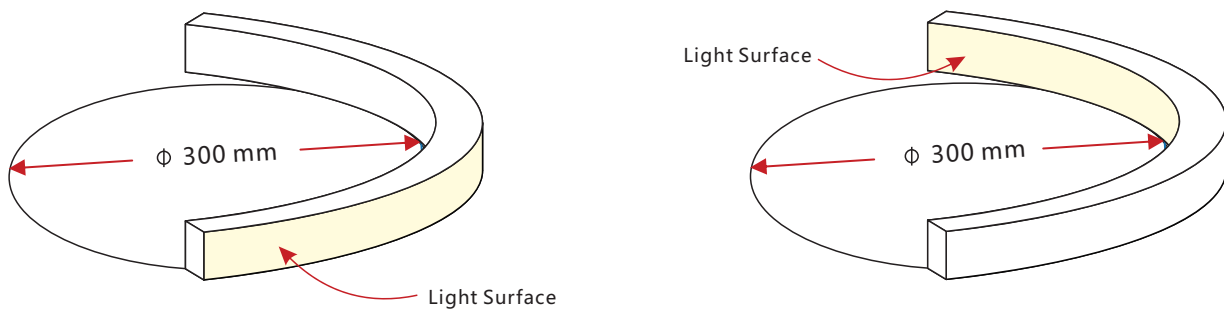

The light can only be bent along the light surface. Do not bend smaller than allowed minimum bend diameter.

3. Types of Connector

3.1 Injection-moulded Connector

Note:

1. Unless otherwise stated, the tolerance of the connector is $\pm 0.5\text{mm}$;
2. Continuous length up to 10m by powering one end.



Injection-moulded Front Connector (bottom)

Connects light to power supply with pre-installed bottom feed cable IP67. Available in 0.3m, 1m, 3m, 5m, 10m lengths.

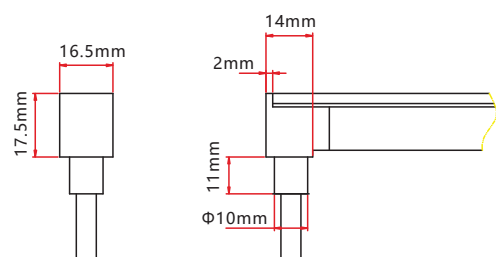



Injection-moulded Front Connector (side)

Connects light to power supply with pre-installed side feed cable, IP67. Available in 0.3m, 1m, 3m, 5m, 10m lengths.

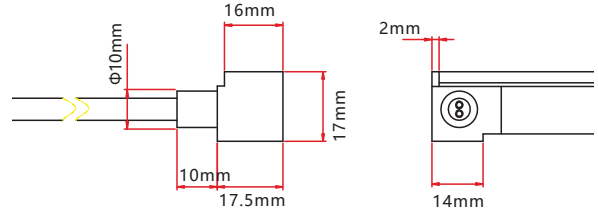

Injection-moulded Front Connector (end)

Connects light to power supply with pre-installed end feed cable, IP67. Available in 0.3m, 1m, 3m, 5m, 10m lengths.

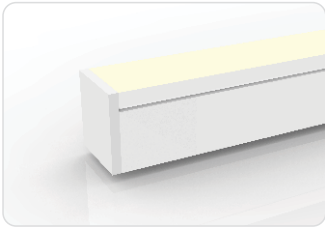
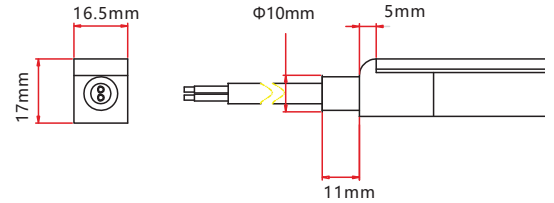

Injection-moulded End Cap

Pre-installed termination protection of the light, IP67.

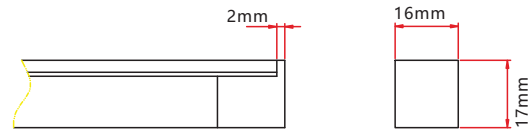

Injection-moulded Jumper

Connects two pieces of lights together with a flexible cable. IP67 Injection-moulded connector. L available in 0.3~1m.

Maximum 8 Jumpers in 20m
Maximum 4 Jumpers in 10m

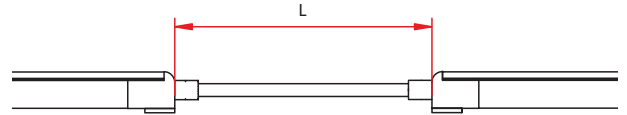

Injection-moulded T-feed

Connects two pieces of lights together with a T joint, energized from middle. IP67 Injection-moulded connector. L1 and L2 available in 0.15~0.5m. L3 available in 0.3-3m.

Maximum 8 T-feeds in 20m
Maximum 4 T-feeds in 10m

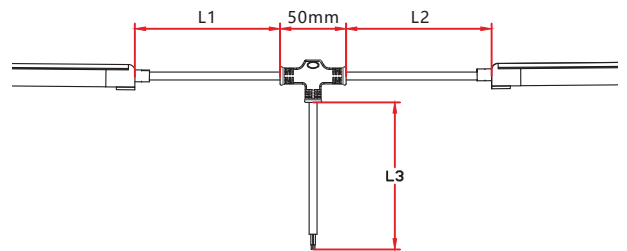

3.2 Anti-wicking Ferrule

Note: Unless otherwise stated, the tolerance is $\pm 0.5\text{mm}$.



Anti-wicking Ferrule

The anti-wicking ferrule is located at 115mm ($\pm 5\text{mm}$ tolerance) from the connector on the cable.

For protection against water ingress from inside of cable wire and hence damage the light.

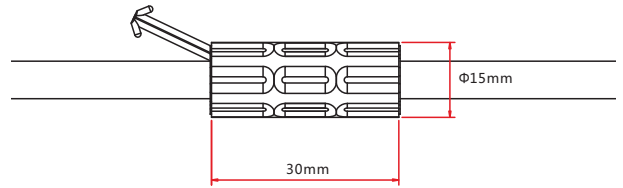

3.3 Male & Female Connector

Note: Unless otherwise stated, the tolerance is $\pm 2\text{mm}$.



Male & female Connector

For plug and play cable junction, DIY or Pre-installed connector, IP68

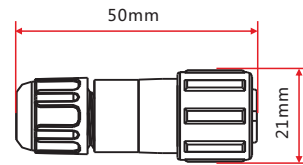

4. Mounting Profile

4.1 Plastic Profile



Note: Unless otherwise stated, the tolerance of the profile is $\pm 0.5\text{mm}$.

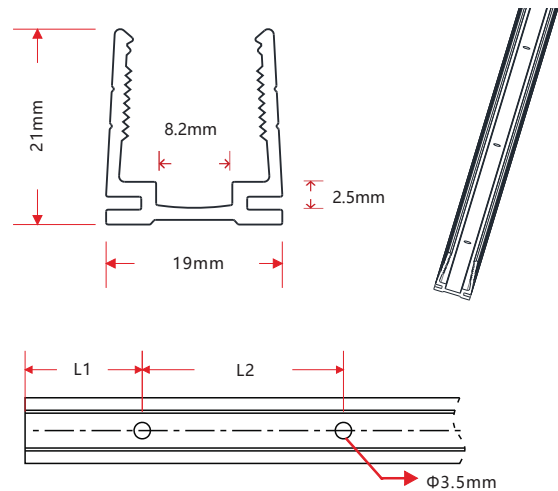

Installation Way



Model	W*H(mm)	Standard Length (mm)	L1 (mm)	L2 (mm)	Screw Hole (mm)	Hole Number	For Product
F22-PC/PL	19*21	500	50	200	$\Phi 3.5$	3	F22
		1000	100	200	$\Phi 3.5$	5	F22
		2000	100	200	$\Phi 3.5$	10	F22

4.2 Spring Clip Aluminium Profile

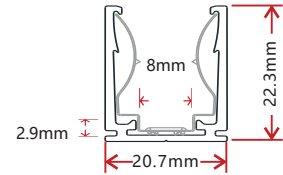

Note: Unless otherwise stated, the tolerance of the profile is $\pm 0.5\text{mm}$.

Installation Way

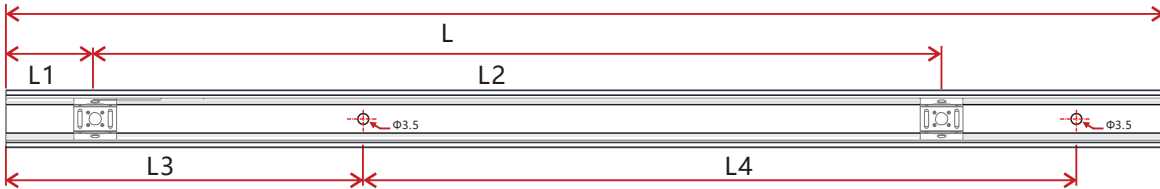

Model	W*H(mm)	Standard Length(mm)	L1(mm)	L2(mm)	L3(mm)	L4(mm)	Hole Screw(mm)	Hole Number	Clip Number
F22-SCA/PL	20.7*22.3	35	17.5	/	5	25	$\Phi 3.5$	2	1
		500	25	150	50	200	$\Phi 3.5$	3	4
		1000	25	190	100	200	$\Phi 3.5$	5	6
		2000	25	195	100	200	$\Phi 3.5$	10	11

4.3 Hybrid Profile

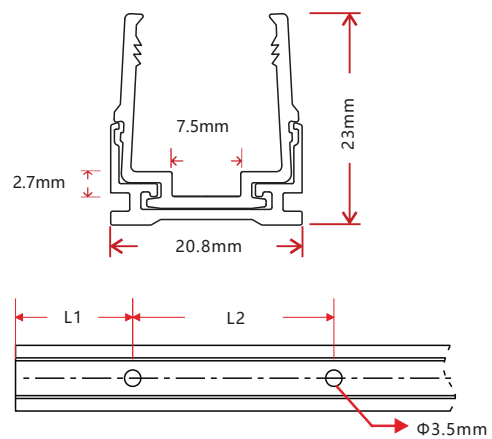
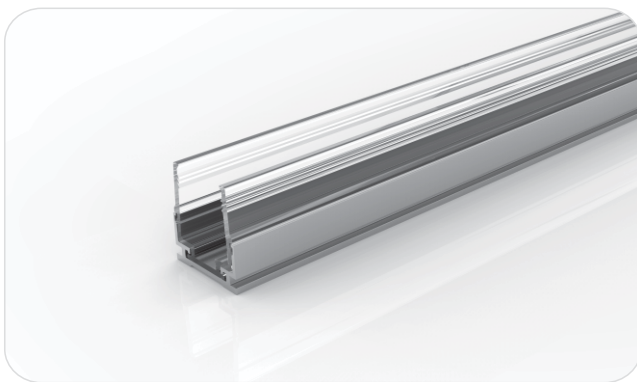

Note: Unless otherwise stated, the tolerance of the profile is $\pm 0.5\text{mm}$.

Installation Way



Model	W*H(mm)	Standard Length (mm)	L1 (mm)	L2 (mm)	Screw Hole (mm)	Hole Number	For Product
F22-PA/PL	20.8*23	35	17.5	/	$\Phi 3.5$	1	F22
		500	50	200	$\Phi 3.5$	3	F22
		1000	100	200	$\Phi 3.5$	5	F22
		2000	100	200	$\Phi 3.5$	10	F22

4.4 Cable Exit Oriented Aluminium Profile (Applicable to Injection-moulded Connector Only)

4.4.1 Spring Clip Aluminium Profile, Bottom Feed

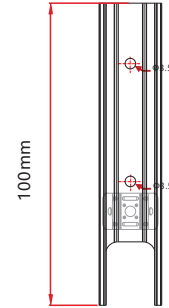
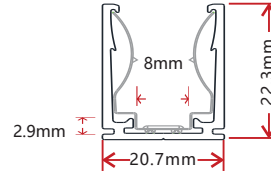
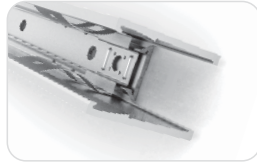
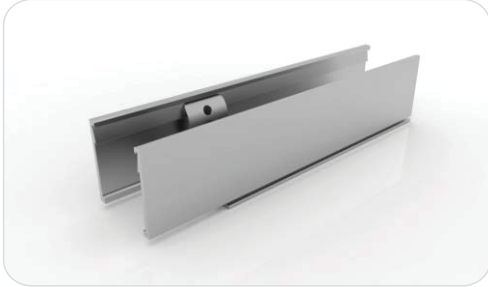

Model: F22-SCA/PL-B

Note: Unless otherwise stated, the tolerance of the profile is $\pm 0.5\text{mm}$.

4.4.2 Spring Clip Aluminium Profile, Middle Feed

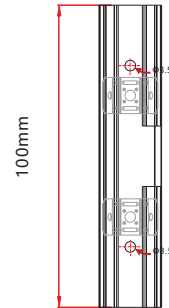
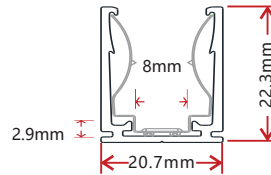

Model: F22-SCA/PL-M

Note: Unless otherwise stated, the tolerance of the profile is $\pm 0.5\text{mm}$.

4.4.3 Spring Clip Aluminium Profile, Side Feed From Left

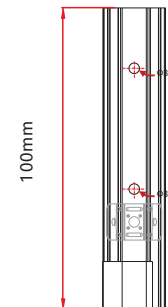
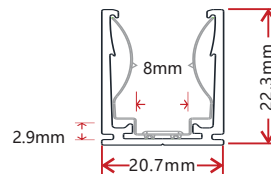

Model: F22-SCA/PL-SL

Note: Unless otherwise stated, the tolerance of the profile is $\pm 0.5\text{mm}$.

4.4.4 Spring Clip Aluminium Profile, Side Feed From Right

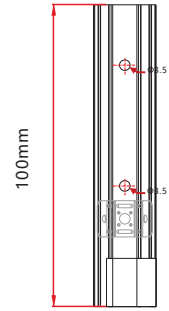
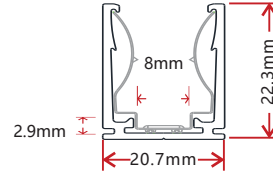

Model: F22-SCA/PL-SR

Note: Unless otherwise stated, the tolerance of the profile is $\pm 0.5\text{mm}$.

4.5 Corner Aluminium Profile (Applicable to Injection-moulded Connector Only)

4.5.1 L Shape Spring Clip Aluminium Profile

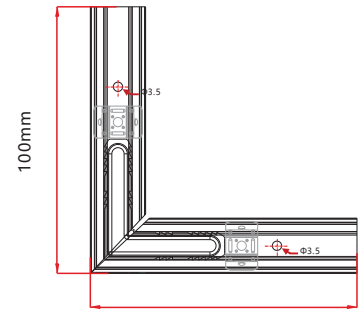
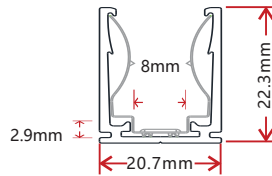
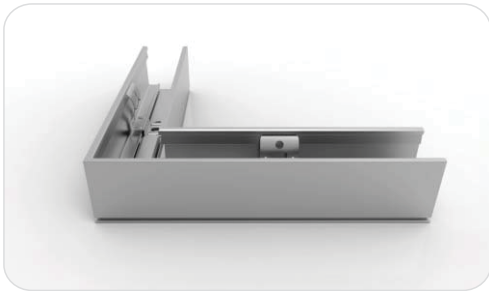

Model: F22-SCA/PL-L

Note: Unless otherwise stated, the tolerance of the profile is $\pm 0.5\text{mm}$.

4.5.2 Inward L Shape Spring Clip Aluminium Profile

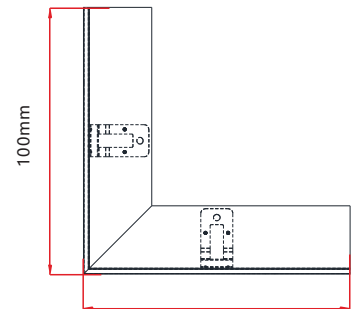
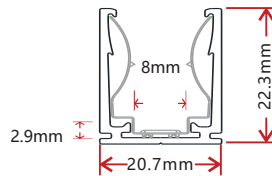

Model: F22-SCA/PL-IL

Note: Unless otherwise stated, the tolerance of the profile is $\pm 0.5\text{mm}$.

4.5.3 Outward L Shape Spring Clip Aluminium Profile



Model: F22-SCA/PL-OL

Note: Unless otherwise stated, the tolerance of the profile is $\pm 0.5\text{mm}$.

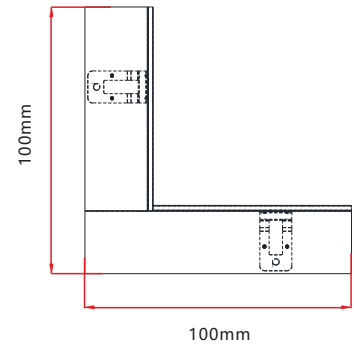
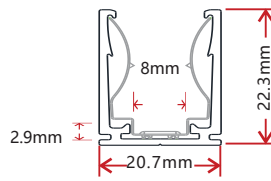

4.5.4 T Shape Spring Clip Aluminium Profile

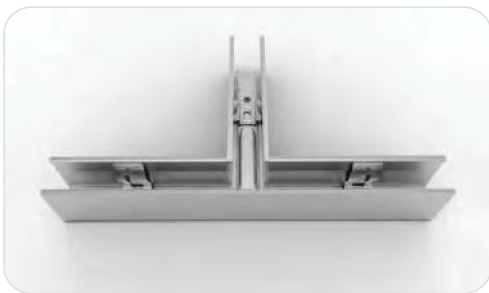

Model: F22-SCA/PL-T

Note: Unless otherwise stated, the tolerance of the profile is $\pm 0.5\text{mm}$.

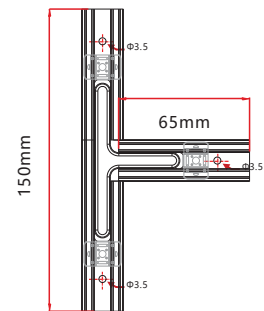
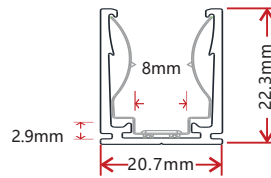

4.5.5 X Shape Spring Clip Aluminium Profile



Model: F22-SCA/PL-X

Note: Unless otherwise stated, the tolerance of the profile is $\pm 0.5\text{mm}$.

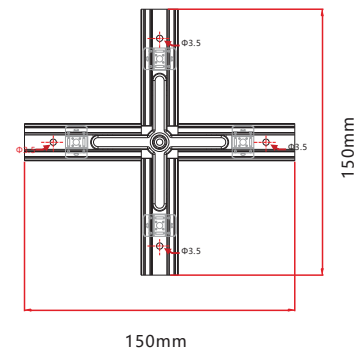
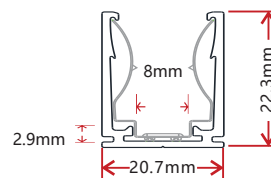

4.6 Bendable Stainless Steel Profile



Model: F22-CS/PL

Note: Unless otherwise stated, the tolerance of the profile is $\pm 0.5\text{mm}$.

Installation Way

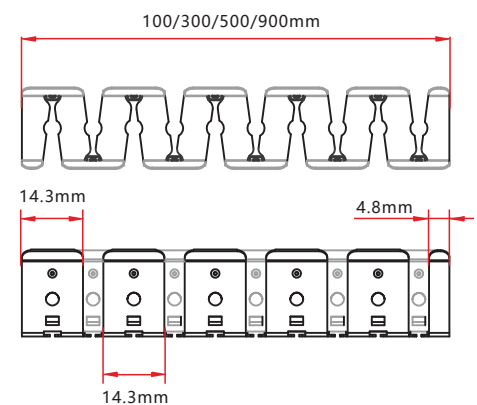
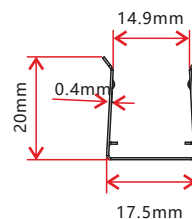

4.7 Recessed Mounting Profile

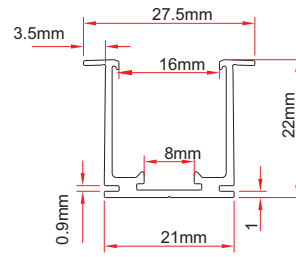

Note: Unless otherwise stated, the tolerance of the profile is $\pm 0.5\text{mm}$.

Installation Way

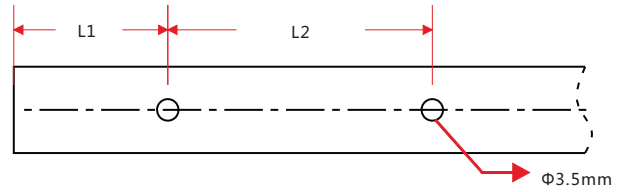

Model	W*H(mm)	Standard Length (mm)	L1 (mm)	L2 (mm)	Screw Hole (mm)	Hole Number	For Product
F22-RMA/PL	18*13.2	35	5	25	Φ3.5	2	F22
		500	50	200	Φ3.5	3	F22
		1000	100	200	Φ3.5	5	F22
		2000	100	200	Φ3.5	10	F22

6. Appendix

6.2 Certificate

Certificating Type	Testing Organization	Certificate Serial Number	Report Reference
UL 2108	UL	20160726-E360029	E360029-20130322
CE-EMC	SGS	SZEM1712012372LMV	SZEM171201237201

6.3 Third-Party Test Report

Testing Item	Testing Organization	Report Number
RoHS	SGS	CANEC1202163502 A01
IP68: Screw type	TUV SUD	68.140.12.136.02
IP68: Clasp type	SGS	GZES140200135301 GZES140200135401 GZES140200135501 GZES140200135701 GZES140200135801
IPX8: Molding type	SGS	SZES141200357301 SZES141200357401 SZES141200357501
IPX8: Snap type	SGS	GZES160600792031

>>Note: The testing reports and certificates are available from the related official website.

6.4 Reliability Test of Light

TESTING ITEM	PERFORMANCE	STANDARD/REFERENCE VALUE/DESCRIPTION
PHOTOMETRIC TESTING	Spectrum Analysis	IES LM 79 (lumen, CCT, CRI, XY, SDCM, wave length)
	Photometric Distribution	IES LM 79(lumen intensity distribution & Lux diagram)
	Lumen maintenance & Life time	IES LM84 & IES TM28
TEMPERATURE RISE TESTING	Normal Temperature Test	UL1598 & UL2388 & IEC60598-1 & IEC60598-2-21
	Abnormal Operation Test	UL1598 & UL2388 & IEC60598-1 & IEC60598-2-21
MECHANICS & PHYSICS TESTING	Bending Test	Manufacturer-defined, 500 cycles
	Swing Test	UL2388, > 750 cycles
	Tensile Test	Manufacturer-defined, > the weight of light in maximum connection length with both ends feed
	Twist Test	Manufacturer-defined, >200 cycles
	Ball impact	UL1598 & UL2388 & IEC60598-1 & IEC60598-2-21
	IK07 IK08	IEC62262
WEATHERING TESTING	Swimming Pool Water Immersion Test	GB9667, PH6.8-7.6, free chlorine 0.3-0.6mg/L
	Sea Water Immersion Test	IEC60598-1, Salinity 4%
	Salt Spray Test	IEC68-2-11
	Outdoor Exposure	Manufacturer-defined
ENVIROMENT TESTING	Flame Resistant Test	UL94
	UV Exposure Test	ASTMG 154, ISO 4892-3, UVA@340nm
	IPX5 IPX6 IPX7 IPX8	IEC60529
ENDURANCE & THERMAL TEST LAB	Temperature Shock Test	Manufacturer-defined, -40°C-60°C (typical temperature range)
	Constant Temperature Test	Manufacturer-defined, 70°C (typical temperature)

6.5 Figures of Typical Characteristics

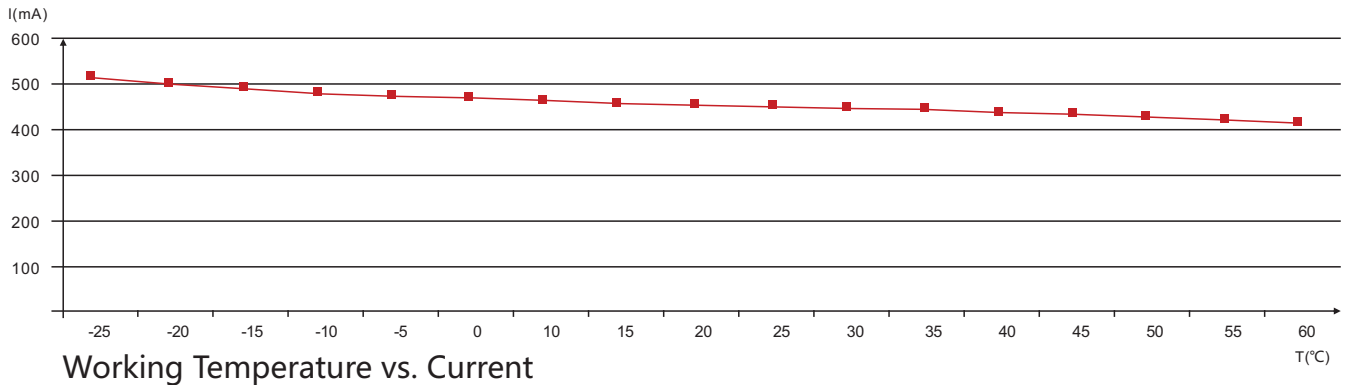

6.6 Wavelength of Color Light

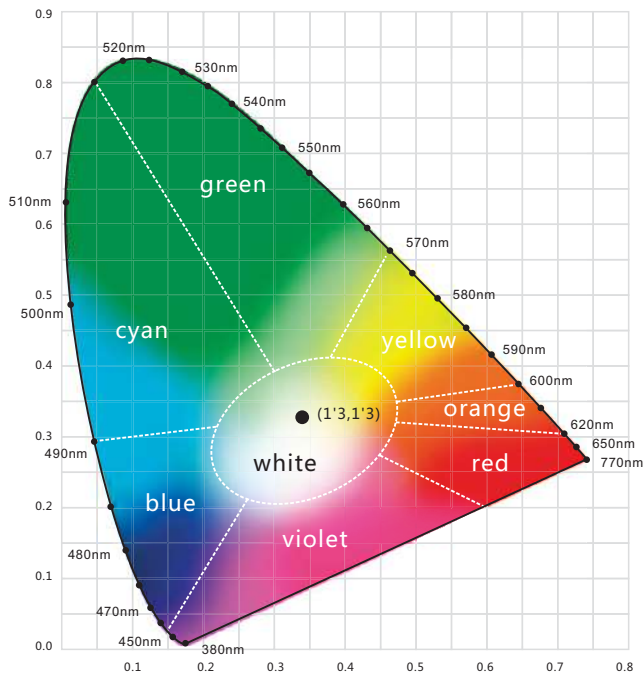

Light Color

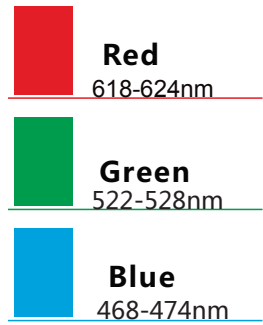

6.7 Loading Chart

Type.	Rated Power /m	Power Supply											
		35w	60w	75w	80w	100w	120w	150w	120w	150w	185w	240w	320w
F22	8w	3.5m	6m	7.5m	8m	10m	12m	15m			18.5m	24m	30m
	12w	2m	4m	5m	5m	6.5m	8m	10m			12m	16m	20m
	15w/16.5w	1.5m	3m	3.5m	4m	4.5m			5.5m	7m	9m	10m	
	22w	1m	2m	2m	3m	3.5m	4m	5m			6.5m	8.5m	10m
Energizing Way		DC input						DC input					

Note : 1. These are the light maximum recommended running length subject to selected power supply.
 2. For example: It is recommended to use one 80W power supply loading maximum 8m light (8w/m) or maximum 5m light (12w/m) by energizing the light one end.